

# Perturbation of System Dynamics and the Covariance Completion Problem

Armin Zare, Mihailo R. Jovanović, and Tryphon T. Georgiou

**Abstract**—We consider the problem of completing partially known sample statistics in a way that is consistent with underlying stochastically driven linear dynamics. Neither the statistics nor the dynamics are precisely known. Thus, our objective is to reconcile the two in a parsimonious manner. To this end, we formulate a convex optimization problem to match available covariance data while minimizing the energy required to adjust the dynamics by a suitable low-rank perturbation. The solution to the optimization problem provides information about critical directions that have maximal effect in bringing model and statistics in agreement.

**Index Terms**—Convex optimization, low-rank perturbation, semi-definite programming, sparsity-promoting optimal control, state covariances, structured matrix completion problems.

## I. INTRODUCTION

Our topic begins with a simplified model of a complex dynamical process together with an incomplete set of covariance statistics. The observed partial statistical signature of the process carries useful information about the underlying dynamics. Thus, our goal is to reconcile the available covariance data with our model by an economical refinement of both, the model and the estimated statistics.

The history and motivation for this subject root in the modeling of fluid flows. In this, the stochastically-forced linearized Navier-Stokes equations around the mean velocity profile have been shown to qualitatively replicate the structural features of shear flows [1]–[4]. The present paper represents an extension of our recent work where we introduced nontrivial (colored) stochastic forcing into linear dynamics in order to account for a partially known output covariance [5]–[9]. We were motivated by the fact that white-in-time stochastic forcing is often insufficient to explain observed correlations [10], [11]. However, insights from that earlier work suggest that the effect of a colored-in-time input process is precisely *equivalent* to a perturbation of the system dynamics, *without* any need to increase the state dimension [8], [9].

Any perturbations in state dynamics can be equivalently represented by state-feedback interactions. Parsimony in our methodology dictates that we penalize both the magnitude

Financial support from the National Science Foundation under Award CMMI 1363266, the Air Force Office of Scientific Research under Award FA9550-16-1-0009, the University of Minnesota Informatics Institute Transdisciplinary Faculty Fellowship, and the University of Minnesota Doctoral Dissertation Fellowship is gratefully acknowledged.

A. Zare and M. R. Jovanović are with the Department of Electrical and Computer Engineering, University of Minnesota, Minneapolis, MN 55455, USA. T. T. Georgiou is with the Department of Mechanical and Aerospace Engineering, University of California, Irvine, CA 92697. E-mails: arminzare@umn.edu, mihailo@umn.edu, tryphon@uci.edu.

as well as the directionality of corresponding correction terms. Thereby, we formulate the problem to match available covariance data while minimizing the energy required to adjust the dynamics by a suitable low-rank perturbation. The solution to the convex optimization problem that we formulate provides information about critical directions that have maximal effect in bringing model and statistics in agreement.

Starting from a pre-specified set of input channels our objective is to identify a small subset that can explain partially-observed second-order statistics via suitable feedback interactions. In general, this is a combinatorial optimization problem. To cope with the combinatorial complexity, we utilize convex characterization that was recently used in the context of optimal sensor and actuator selection [12], [13]. This allows us to cast our problem as a semidefinite program.

Our problem can be viewed as having a dual interpretation. It can be considered as a static state-feedback synthesis approach to an inverse problem that identifies dynamical feedback interactions which account for available statistical signatures. On the other hand, it can also be considered as an identification problem that aims to explain available statistics via suitable low-rank perturbations of the linear dynamics.

Our presentation is organized as follows. In Section II, we provide a brief summary of the covariance completion problem and draw connections to covariance control problems. In Section III, we pose the problem as a state-feedback synthesis and provide a convex formulation. In Section IV, we offer an example to highlight the utility of our approach. We conclude with remarks and future directions in Section V.

## II. BACKGROUND

Consider a linear time-invariant (LTI) system with state-space representation

$$\begin{aligned} \dot{x} &= Ax + Bf \\ y &= Cx \end{aligned} \quad (1)$$

where  $x(t) \in \mathbb{C}^n$  is the state vector,  $y(t) \in \mathbb{C}^p$  is the output,  $f(t) \in \mathbb{C}^m$  is a stationary zero-mean stochastic process,  $A \in \mathbb{C}^{n \times n}$  is the dynamic matrix, and  $B \in \mathbb{C}^{n \times m}$  is the input matrix with  $m \leq n$ . For Hurwitz  $A$  and controllable  $(A, B)$ , a positive definite matrix  $X$  qualifies as the steady-state covariance matrix of the state vector

$$X := \lim_{t \rightarrow \infty} \mathbf{E}(x(t)x^*(t)),$$

if and only if the linear equation

$$AX + XA^* = -(BH^* + HB^*), \quad (2)$$

is solvable for  $H \in \mathbb{C}^{n \times m}$  [14], [15]. Here,  $\mathbf{E}$  is the expectation operator,  $H$  is a matrix that contains spectral information about the stochastic input process and is related to the cross-correlation between the input  $f$  and the state  $x$  [9, Appendix B], and  $*$  denotes the complex conjugate transpose. For a white-in-time input  $f$  with covariance  $W$ , the covariance  $X$  satisfies the algebraic Lyapunov equation

$$AX + XA^* = -BWB^*. \quad (3)$$

The main difference between (2) and (3) is that the right-hand-side in (2) is allowed to be sign-indefinite, thereby allowing for colored-in-time stochastic inputs. Clearly, for  $H = BW/2$ , (2) simplifies to the Lyapunov equation (3).

The algebraic relation between second-order statistics of the state and forcing can be used to explain partially known sampled second-order statistics using stochastically-driven LTI systems [5], [8]. While the dynamical generator  $A$  is known, the origin and directionality of stochastic excitation  $f$  is unknown. It is also important to restrict the complexity of the forcing model. This complexity is quantified by the number of degrees of freedom that are directly influenced by stochastic forcing and translates into the number of input channels or  $\text{rank}(B)$ . It can be shown that the rank of  $B$  is closely related to the signature of the matrix

$$\begin{aligned} Z &:= -(AX + XA^*) \\ &= BH^* + HB^*. \end{aligned}$$

The signature of a matrix is determined by the number of its positive, negative, and zero eigenvalues. In addition, the rank of  $Z$  bounds the rank of  $B$  [5], [8].

Based on this, the problem of identifying low-complexity structures for stochastic forcing can be formulated as the following structured covariance completion problem [8]

$$\begin{aligned} &\underset{X, Z}{\text{minimize}} && -\log \det(X) + \gamma \|Z\|_* \\ &\text{subject to} && AX + XA^* + Z = 0 \\ &&& (CXC^*) \circ E - G = 0. \end{aligned} \quad (4)$$

Here,  $\gamma$  is a positive regularization parameter, the matrices  $A$ ,  $C$ ,  $E$ , and  $G$  are problem data, and the Hermitian matrices  $X$ ,  $Z \in \mathbb{C}^{n \times n}$  are optimization variables. Entries of  $G$  represent partially available second-order statistics of the output  $y$ , the symbol  $\circ$  denotes elementwise matrix multiplication, and  $E$  is the structural identity matrix,

$$E_{ij} = \begin{cases} 1, & \text{if } G_{ij} \text{ is available} \\ 0, & \text{if } G_{ij} \text{ is unavailable.} \end{cases}$$

Convex optimization problem (4) combines the nuclear norm with an entropy function in order to target low-complexity structures for stochastic forcing and facilitate construction of a particular class of low-pass filters that generate colored-in-time forcing correlations. The nuclear norm, i.e., the sum of singular values of a matrix,  $\|Z\|_* := \sum_i \sigma_i(Z)$ , is used as a proxy for rank minimization [16], [17]. On the other hand, the logarithmic barrier function

in the objective is introduced to guarantee the positive definiteness of the state covariance matrix  $X$ .

The solution to (4) can be translated into a dynamical representation for colored-in-time stochastic forcing by designing linear filters that provide the suitable forcing into system (1); see Fig. 1(a). The filter dynamics are given by the state-space representation

$$\dot{\xi} = (A - BK)\xi + Bd \quad (5a)$$

$$f = -K\xi + d, \quad (5b)$$

where  $d$  is a white stochastic process with covariance  $\Omega \succ 0$  and

$$K = \frac{1}{2} \Omega B^* X^{-1} - H^* X^{-1}. \quad (5c)$$

Here, the matrices  $B$  and  $H$  correspond to the factorization of the matrix  $Z$  (cf. (2)) which results from solving convex optimization problem (4); see [5], [8] for details.

From an alternative viewpoint, the constructed class of filters described by (5) are related to the covariance control problem studied in [18], [19]; see [8] for additional details. In other words, the cascade interconnection of the filter and linear dynamics can be equivalently represented by

$$\dot{x} = Ax + Bu + Bd, \quad (6a)$$

where  $d$  is again white with covariance  $\Omega$ , and  $u$  is given by

$$u = -Kx. \quad (6b)$$

Substitution of (6b) into (6a) yields the following state-space representation

$$\dot{x} = (A - BK)x + Bd. \quad (6c)$$

In this case, a choice of non-zero  $K$  can be used to assign different values to the covariance matrix  $X$ ; see Fig. 1(b). For  $A - BK$  Hurwitz,  $X$  satisfies

$$(A - BK)X + X(A - BK)^* + B\Omega B^* = 0. \quad (7)$$

Any  $X \succ 0$  satisfying (7) also satisfies (2) with  $H = -XK^* + \frac{1}{2}B\Omega$ . Conversely, if  $X \succ 0$  satisfies (2), then it also satisfies (7) for  $K = \frac{1}{2}\Omega B^* X^{-1} - H^* X^{-1}$  and  $A - BK$  is Hurwitz. Thus, for a stationary state covariance  $X \succ 0$ , the problem of identifying the stochastic input  $f$  in (1) is equivalent to assigning the feedback gain matrix  $K$  in (6).

### III. COVARIANCE COMPLETION VIA MINIMUM ENERGY CONTROL

We next utilize representation (6) to propose an alternative method for completing partially known second-order statistics using state-feedback synthesis. In general, there is more than one choice of  $K$  that provides consistency with available steady-state statistics. We propose to select an optimal feedback gain  $K$  that minimizes the control energy in statistical steady-state

$$\lim_{t \rightarrow \infty} \mathbf{E}(u^*(t)u(t)).$$

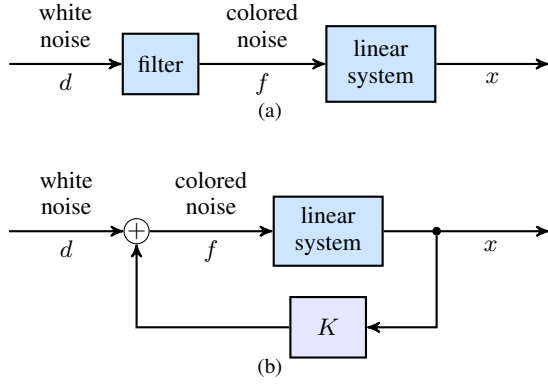

Fig. 1. (a) A cascade connection of an LTI system with a linear filter that is designed to account for the sampled steady-state covariance matrix  $X$ ; (b) An equivalent feedback representation of the cascade connection in (a).

Such  $K$  can be equivalently obtained by minimizing  $\text{trace}(KXK^*)$  subject to (7) and a linear constraint that comes from the known output correlations,

$$(CXC^*) \circ E - G = 0.$$

In addition, it is desired to limit the number of degrees of freedom that are directly influenced by the state-feedback  $u$  and stochastic forcing  $d$  in (6). This also translates into minimizing the number of input channels or columns of the input matrix  $B$  that perturb the dynamical generator  $A$  in (7); see [8], [9] for details.

Herein, we introduce a covariance completion framework which consists of two steps: identification and polishing. In the identification step, we solve the minimum-energy covariance completion problem augmented by a sparsity-promoting regularizer. This allows us to identify a subset of input channels that strike a balance between control energy and the number of used input channels (and thereby the rank of the dynamical perturbation  $BK$ ). In the polishing step, we further reduce the control energy and improve the quality of completion. This is accomplished by solving the minimum-energy covariance completion problem using the identified input channels.

#### A. Identification of essential input channels

As aforementioned, the covariance completion problem (4) uses a nuclear norm regularization in order to provide a bound on the least number of colored-in-time input channels that are required to account for the known second-order statistics. Herein, we consider the state-space representation

$$\dot{x} = (A - BK)x + Bd$$

where  $d$  is a zero-mean white stochastic process with covariance  $\Omega$ ,  $B$  is the input matrix,  $A$  is Hurwitz, and the pair  $(A, B)$  is controllable. Starting from a given matrix  $B$ , we seek a subset of available input channels that are sufficient for the purpose of accounting for the observed second-order statistics. This is accomplished by formulating

an optimization problem in which the performance index  $\text{trace}(KXK^*)$  is augmented with a term that promotes row-sparsity of the feedback gain matrix  $K$ . When the  $i$ th row of  $K$  is identically equal to zero, the  $i$ th input channel in the matrix  $B$  is not used. Therefore, we can identify a subset of critical input channels by promoting row-sparsity of  $K$ . This approach not only reduces the number of colored-in-time input channels, but it also uncovers the precise dynamical feedback interactions that are required to reconcile the available covariance data with the given linear dynamics.

The regularized minimum-control-energy covariance completion problem can be formulated as,

$$\begin{aligned} & \underset{X, K, \Omega}{\text{minimize}} && \text{trace}(K^*XK) + \gamma \sum_{i=1}^n w_i \|e_i^* K_i\|_2 \\ & \text{subject to} && (A - BK)X + X(A - BK)^* + V(\Omega) = 0 \\ & && (CXC^*) \circ E - G = 0 \\ & && X \succ 0, \end{aligned} \tag{8}$$

with  $V(\Omega) := B\Omega B^*$ . Here, matrices  $A$ ,  $B$ ,  $C$ ,  $E$ , and  $G$  are problem data, and matrices  $X \in \mathbb{C}^{n \times n}$ ,  $K \in \mathbb{C}^{m \times n}$ , and  $\Omega \in \mathbb{C}^{m \times m}$  are optimization variables. The regularization parameter  $\gamma > 0$  specifies the relative importance of the sparsity-promoting term,  $w_i$  are nonzero weights, and  $e_i$  is the  $i$ th unit vector in  $\mathbb{R}^m$ .

Since the hermitian matrix  $X$  is positive definite and therefore invertible, the standard change of coordinates  $Y := KX$  brings problem (8) into the following form

$$\begin{aligned} & \underset{X, Y, \Omega}{\text{minimize}} && \text{trace}(YX^{-1}Y^*) + \gamma \sum_{i=1}^n w_i \|e_i^* Y_i\|_2 \\ & \text{subject to} && AX + XA^* - BY - Y^*B^* + V(\Omega) = 0 \\ & && (CXC^*) \circ E - G = 0 \\ & && X \succ 0. \end{aligned} \tag{CC}$$

Here, we have utilized the equivalence between the row-sparsity of  $K$  and the row-sparsity of  $Y$  [12]. The convexity of (CC) follows from the convexity of its objective function and the convexity of the constraint set [20]. Furthermore, this optimization problem can be recast as an SDP by taking the Schur complement of  $YX^{-1}Y^*$  [21]. Finally, the optimal feedback gain matrix can be recovered as  $K = YX^{-1}$ .

The SDP characterization of problem (CC) can be solved efficiently using general-purpose solvers for small-size problems. We are currently developing customized algorithms that exploit the structure of (CC) in order to gain computational efficiency and improve scalability.

*Iterative reweighting:* In optimization problem (CC) the weighted  $\ell_2$  norm is used to promote row sparsity of the matrix  $Y$ . This choice is inspired by the exact correspondence between the weighted  $\ell_1$  norm, i.e.,  $\sum_i w_i |x_i|$  with  $w_i = 1/|x_i|$  for  $x_i \neq 0$ , and the cardinality function  $\text{card}(x)$ . Since this choice of weights cannot be implemented, the

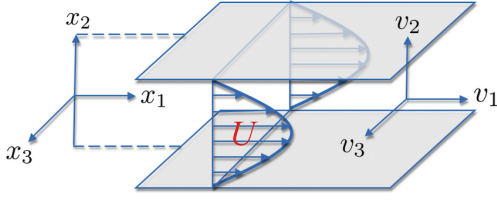

Fig. 2. Geometry of a three-dimensional pressure-driven channel flow.

iterative reweighting scheme was proposed instead in [22]. We follow a similar approach and update the weights using

$$w_i^{j+1} = \frac{1}{\|e_i^* Y^j\|_2 + \epsilon}, \quad (9)$$

where  $Y^j$  denotes the solution to problem (CC) in the  $j$ th reweighting step. The small positive parameter  $\epsilon$  ensures that the weights are well-defined.

### B. Polishing step

In the polishing step, we consider the system

$$\dot{x} = (A - B_2 K)x + B d.$$

The matrix  $B_2 \in \mathbb{C}^{n \times q}$  is obtained by eliminating the columns of  $B$  which correspond to the identified row sparsity structure of  $Y$ , where  $q$  denotes the number of retained input channels. For this system, we solve optimization problem (CC) with  $\gamma = 0$ . This step allows us to identify the optimal matrix  $Y \in \mathbb{C}^{q \times n}$  and subsequently the optimal feedback gain  $K \in \mathbb{C}^{q \times n}$  for a system with a lower number of input control channels. As we demonstrate in our computational experiments, polishing not only reduces the energy of the control input but it can also improve the quality of completion of the covariance matrix  $X$ .

## IV. AN EXAMPLE

In an incompressible channel-flow, with geometry shown in Fig. 2, we study the dynamics of infinitesimal fluctuations around the parabolic mean velocity profile,  $\bar{\mathbf{u}} = [U(x_2) \ 0 \ 0]^T$  with  $U(x_2) = 1 - x_2^2$ . Here,  $x_1$ ,  $x_2$ , and  $x_3$  denote the streamwise, wall-normal and spanwise coordinates, respectively; see Fig. 2. Finite dimensional approximation of the linearized Navier-Stokes equations around  $\bar{\mathbf{u}}$  results in the following state-space representation

$$\begin{aligned} \dot{x}(\mathbf{k}, t) &= A(\mathbf{k})x(\mathbf{k}, t) + \xi(\mathbf{k}, t), \\ y(\mathbf{k}, t) &= C(\mathbf{k})x(\mathbf{k}, t). \end{aligned} \quad (10a)$$

Here,  $x = [v_2^T \ \eta^T]^T \in \mathbb{C}^{2N}$  is the state of the linearized model,  $v_2$  and  $\eta = \partial_{x_3} v_1 - \partial_{x_1} v_3$  are the wall-normal velocity and vorticity, the output  $y = [v_1^T \ v_2^T \ v_3^T]^T \in \mathbb{C}^{3N}$  denotes the fluctuating velocity vector,  $\xi$  is a stochastic forcing disturbance,  $\mathbf{k} = [k_x \ k_z]^T$  denotes the vector of horizontal wavenumbers, and the input matrix is the identity

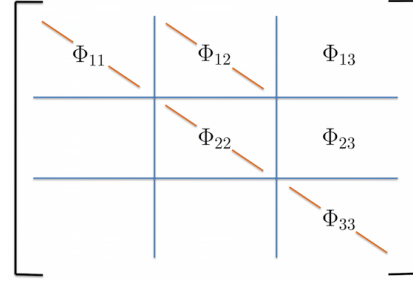

Fig. 3. Structure of the output covariance matrix  $\Phi$ . Available one-point velocity correlations in the wall-normal direction represent diagonal entries of the blocks in the velocity covariance matrix  $\Phi$ .

$I_{2N \times 2N}$ . A detailed description of the dynamical matrix  $A$  and output matrix  $C$  can be found in [3].

We assume that the stochastic disturbance  $\xi$  is generated by a low-pass filter with state-space representation

$$\dot{\xi}(\mathbf{k}, t) = -\xi(\mathbf{k}, t) + d(t). \quad (10b)$$

Here,  $d$  denotes a zero mean unit variance white process.

The steady-state covariance of system (10) can be found as the solution to the Lyapunov equation

$$\tilde{A}\Sigma + \Sigma\tilde{A}^* + \tilde{B}\tilde{B}^* = 0$$

where

$$\tilde{A} = \begin{bmatrix} A & I \\ O & -I \end{bmatrix}, \quad \tilde{B} = \begin{bmatrix} 0 \\ I \end{bmatrix}$$

and

$$\Sigma = \begin{bmatrix} \Sigma_{xx} & \Sigma_{x\xi} \\ \Sigma_{\xi x} & \Sigma_{\xi\xi} \end{bmatrix}.$$

Here, the sub-covariance  $\Sigma_{xx}$  denotes the state covariance of system (10a). At any horizontal wavenumber pair  $\mathbf{k}$ , the steady-state covariance matrices of the output  $y$  and the state  $x$  are related by

$$\Phi(\mathbf{k}) = C(\mathbf{k})\Sigma_{xx}(\mathbf{k})C^*(\mathbf{k}),$$

Figure 3 shows the structure of the output covariance matrix  $\Phi$ .

For the horizontal wavenumber pair  $(k_x, k_z) = (0, 1)$ , Fig. 4(a, c, e, g) shows the color-plots of the streamwise  $\Phi_{11}$ , wall-normal  $\Phi_{22}$ , spanwise  $\Phi_{33}$ , and the streamwise/wall-normal  $\Phi_{12}$  two-point correlation matrices in the wall-normal direction  $x_2$ . In this example, we assume that the one-point velocity correlations, or diagonal entries of these covariance matrices are available. We set the covariance of white noise disturbances to the identity ( $\Omega = I$ ) and do not treat it as an optimization variable in (CC). For this example, we use  $N = 11$  collocation points to discretize the differential operators in the wall-normal direction  $x_2$ .

Figure 5 shows the  $\gamma$ -dependence of the relative Frobenius norm error in recovering the true covariance  $\Sigma_{xx}$  before and after polishing. As shown in Fig. 5, the polishing step can

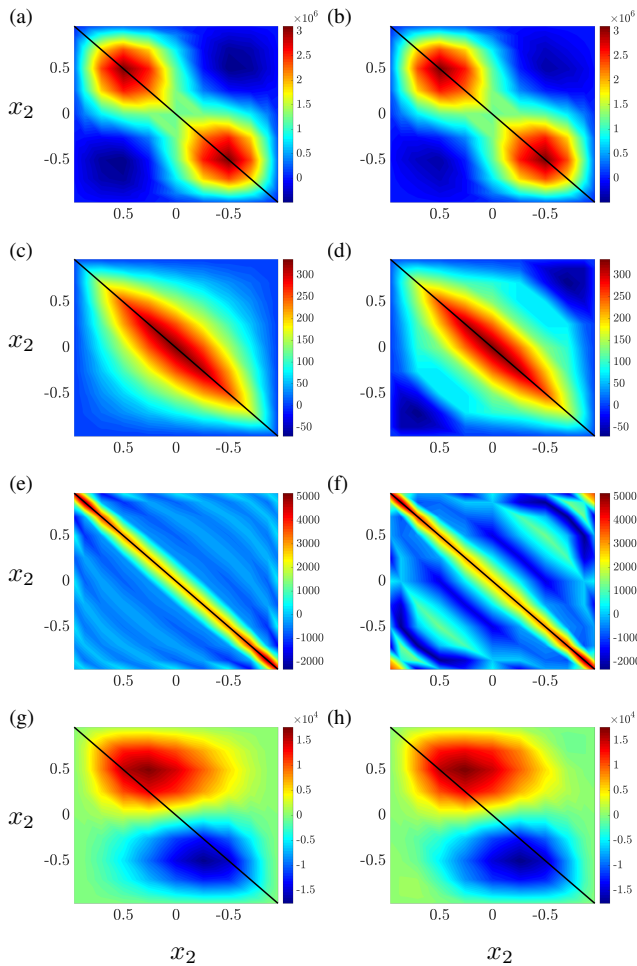

Fig. 4. True covariance matrices of the output velocity field (a, c, e, g), and covariance matrices resulting from solving optimization problem (CC) with  $\gamma = 10^4$  followed by a polishing step (b, d, f, h). (a, b) Streamwise  $\Phi_{11}$ , (c, d) wall-normal  $\Phi_{22}$ , (e, f) spanwise  $\Phi_{33}$ , and (g, h) the streamwise/wall-normal  $\Phi_{12}$  two-point correlation matrices at  $(k_x, k_z) = (0, 1)$ . The one-point correlation profiles that are used as problem data in (CC) are marked by black lines along the main diagonals.

indeed improve the quality of completion in the covariance matrix  $X$ . The best completion is achieved for high values of  $\gamma$  (96% recovery). Fig. 4(b, d, f, h) shows the streamwise, wall-normal, spanwise, and the streamwise/wall-normal two-point correlation matrices resulting from solving (CC) with  $\gamma = 10^4$  followed by polishing.

Figure 6 shows the configuration of input channels that are retained as  $\gamma$  is increased. It is evident that as  $\gamma$  increases more control input channels are eliminated. In this example, the initial input matrix is the identity  $I_{2N \times 2N}$ . Since the state is formed as  $x = [v^T \ \eta^T]^T$ , the first and last  $N$  input channels can be considered as entering into the dynamics of wall-normal velocity and wall-normal vorticity, respectively. Notably, input channels that enter the dynamics of wall-normal velocity are more important with more emphasis placed on excitations that are located in the vicinity of

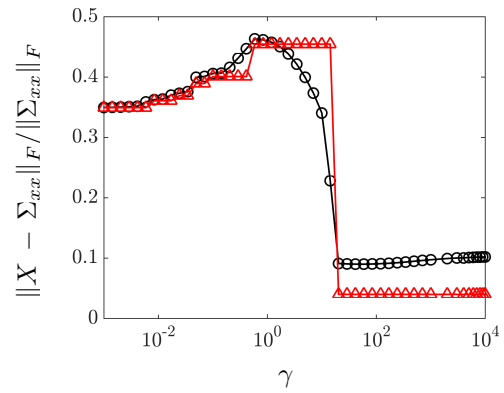

Fig. 5. The  $\gamma$ -dependence of the relative Frobenius norm error between the true state covariance  $\Sigma_{xx}$  and the solution  $X$  to (CC) before (O) and after ( $\Delta$ ) polishing, for the channel flow with  $N = 11$  collocation points in channel height.

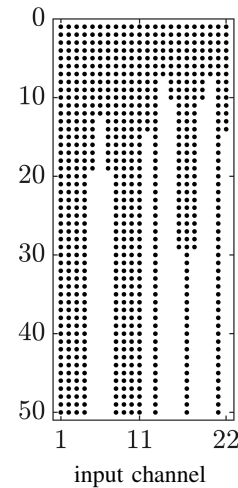

Fig. 6. Retained columns of the input matrix  $B$  as  $\gamma$  increases. A black dot indicates the presence of the corresponding input channel. The top row ( $\gamma = 0$ ) shows the use of all channels, and the bottom row ( $\gamma = 10^4$ ) shows the least number of channels required for accounting for the observed statistics.

channel walls.

When the reweighting scheme is employed, for each value of  $\gamma$ , the optimization problem (CC) is solved 10 times, updating the weights using (9) and retaining them as we increase  $\gamma$ . Figure 7 illustrates the utility of the iterative reweighting scheme. When constant and uniform sparsity-promoting weights are used, large values of  $\gamma$  are required to eliminate input channels, and even with the highest values of the sparsity-promoting parameter ( $\gamma = 10^4$ ) only 5 input channels were eliminated from the second half of columns of  $B$ . For the same value of  $\gamma$ , problem (CC) with the iterative reweighting scheme eliminates 11 input channels.

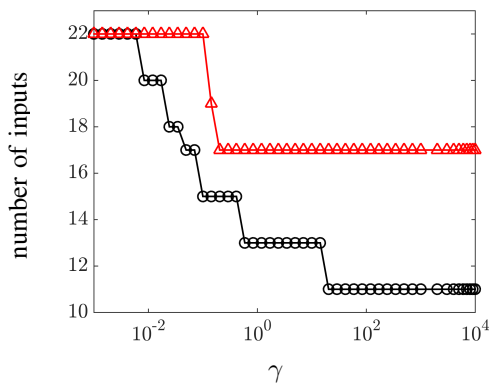

Fig. 7. The  $\gamma$ -dependence of the number of retained input channels after solving problem (CC) in the case of iterative reweighting ( $\circ$ ) and in the case of constant weights ( $\Delta$ ).

## V. CONCLUDING REMARKS

We have examined the problem of explaining partially known second-order statistics using stochastically-forced linear models. While the linearized model and an incomplete set of covariance statistics are known, the nature and directionality of disturbances that can explain these statistics are unknown. This inverse problem can be formulated as a convex covariance completion problem, which utilizes nuclear norm minimization to identify forcing correlation structures of low-rank. The low-rank objective bounds the number of input channels which directly influence the state dynamics. We show that this problem can be alternatively formulated as a covariance control problem in which we identify the suitable feedback interactions that explain the available statistics. We employ a convenient change of variables through which the problem of minimizing the number of input channels translates into promoting sparsity on the rows of the feedback gain matrix. This allows for the exact identification of critical input directions that have most profound effect in bringing model and statistics in agreement.

Our ongoing effort is directed toward the development of customized optimization algorithms which efficiently solve the minimum energy covariance completion problem for problems with a large number of state variables.

## REFERENCES

- [1] B. F. Farrell and P. J. Ioannou, "Stochastic forcing of the linearized Navier-Stokes equations," *Phys. Fluids A*, vol. 5, no. 11, pp. 2600–2609, 1993.
- [2] B. Bamieh and M. Dahleh, "Energy amplification in channel flows with stochastic excitation," *Phys. Fluids*, vol. 13, no. 11, pp. 3258–3269, 2001.
- [3] M. R. Jovanović and B. Bamieh, "Componentwise energy amplification in channel flows," *J. Fluid Mech.*, vol. 534, pp. 145–183, July 2005.
- [4] R. Moarref and M. R. Jovanović, "Model-based design of transverse wall oscillations for turbulent drag reduction," *J. Fluid Mech.*, vol. 707, pp. 205–240, September 2012.
- [5] Y. Chen, M. R. Jovanović, and T. T. Georgiou, "State covariances and the matrix completion problem," in *Proceedings of the 52nd IEEE Conference on Decision and Control*, Florence, Italy, 2013, pp. 1702–1707.

- [6] A. Zare, M. R. Jovanović, and T. T. Georgiou, "Completion of partially known turbulent flow statistics," in *Proceedings of the 2014 American Control Conference*, Portland, OR, 2014, pp. 1680–1685.
- [7] A. Zare, M. R. Jovanović, and T. T. Georgiou, "Alternating direction optimization algorithms for covariance completion problems," in *Proceedings of the 2015 American Control Conference*, Chicago, IL, 2015, pp. 515–520.
- [8] A. Zare, Y. Chen, M. R. Jovanović, and T. T. Georgiou, "Low-complexity modeling of partially available second-order statistics: theory and an efficient matrix completion algorithm," *IEEE Trans. Automat. Control*, 2016, doi:10.1109/TAC.2016.2595761; also arXiv:1412.3399.
- [9] A. Zare, M. R. Jovanović, and T. T. Georgiou, "Color of turbulence," *J. Fluid Mech.*, 2016, submitted; also arXiv:1602.05105.
- [10] M. R. Jovanović and B. Bamieh, "Modelling flow statistics using the linearized Navier-Stokes equations," in *Proceedings of the 40th IEEE Conference on Decision and Control*, Orlando, FL, 2001, pp. 4944–4949.
- [11] M. R. Jovanović and T. T. Georgiou, "Reproducing second order statistics of turbulent flows using linearized Navier-Stokes equations with forcing," in *Bulletin of the American Physical Society*, Long Beach, CA, November 2010.
- [12] B. Polyak, M. Khlebnikov, and P. Shcherbakov, "An LMI approach to structured sparse feedback design in linear control systems," in *Proceedings of the 2013 European Control Conference*, 2013, pp. 833–838.
- [13] N. K. Dhingra, M. R. Jovanović, and Z. Q. Luo, "An ADMM algorithm for optimal sensor and actuator selection," in *Proceedings of the 53rd IEEE Conference on Decision and Control*, Los Angeles, CA, 2014, pp. 4039–4044.
- [14] T. T. Georgiou, "The structure of state covariances and its relation to the power spectrum of the input," *IEEE Trans. Autom. Control*, vol. 47, no. 7, pp. 1056–1066, 2002.
- [15] T. T. Georgiou, "Spectral analysis based on the state covariance: the maximum entropy spectrum and linear fractional parametrization," *IEEE Trans. Autom. Control*, vol. 47, no. 11, pp. 1811–1823, 2002.
- [16] M. Fazel, "Matrix rank minimization with applications," Ph.D. dissertation, Stanford University, 2002.
- [17] B. Recht, M. Fazel, and P. A. Parrilo, "Guaranteed minimum-rank solutions of linear matrix equations via nuclear norm minimization," *SIAM Rev.*, vol. 52, no. 3, pp. 471–501, 2010.
- [18] A. Hotz and R. E. Skelton, "Covariance control theory," *Int. J. Control*, vol. 46, no. 1, pp. 13–32, 1987.
- [19] Y. Chen, T. T. Georgiou, and M. Pavon, "Optimal steering of a linear stochastic system to a final probability distribution, Part II," *IEEE Trans. Automat. Control*, 2015.
- [20] S. Boyd and L. Vandenberghe, *Convex optimization*. Cambridge University Press, 2004.
- [21] G. E. Dullerud and F. Paganini, *A course in robust control theory: a convex approach*. New York: Springer-Verlag, 2000.
- [22] E. J. Candes, M. B. Wakin, and S. P. Boyd, "Enhancing sparsity by reweighted  $\ell_1$  minimization," *J. Fourier Anal. Appl.*, vol. 14, no. 5-6, pp. 877–905, 2008.